

BG ФРИТЮРНИК С ГОРЕЩ ВЪЗДУХ	2
NL AIRFRYER	7
EN AIRFRYER	12
FR FRITEUSE À AIR	17
DE HEISSLUFTFRITTEUSE	22
EL ΦΡΙΤΕΖΑ ΑΕΡΟΣ	27
PT FRITADEIRA SEM ÓLEO	32
ES FREIDORA DE AIRE	37
AR مقلاة هوائية	45

USER MANUAL

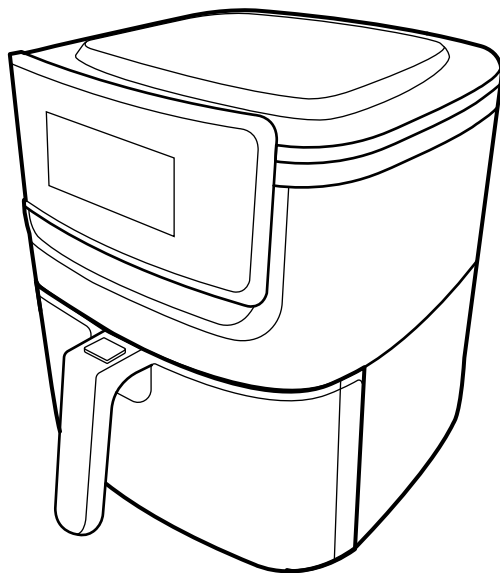

AF6-1-4ST
AF6-1-6ST

AEG

1. ОБЩ ПРЕГЛЕД

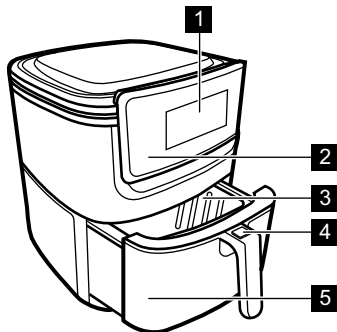

- 1** Екран
- 2** Контролен панел
- 3** Кошница
- 4** Безопасно заключване със защитен капак
- 5** Грил / тиган за печене

2. КОМАНДНО ТАБЛО

2.1 Контролен панел

Запознайте се с основните икони на контролния панел и екрана.

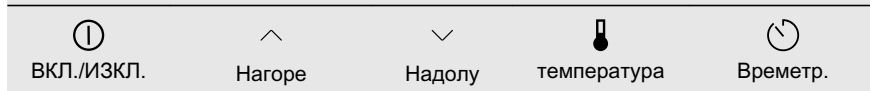

Помощ при готвене – гответе с автоматични настройки за час и температура.



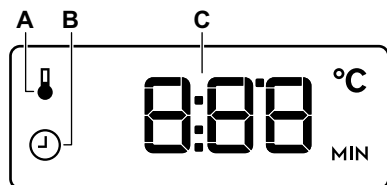

2.2 Екран



- A.** Температурна настройка
- B.** Свръвяване на часа
- C.** Час/температура

3. ПРЕДИ ПЪРВА УПОТРЕБА

	Отстранете опаковките, етикетите и защитното фолио.
	Почистете кошницата и грила/тигана с топла вода, течен препарат за почистване и мека кърпа. Подсушете вътрешната и външната част на уреда с кърпа.
	При първата употреба продуктът може да отдели нетоксична миризма, която веднага изчезва. Това няма да повлияе на употребата.

4. ВСЕКИДНЕВНА УПОТРЕБА

4.1 Начин на използване: тава и кошница

Поставете уреда на стабилна повърхност.

1. Извадете грила/тигана и го поставете на стабилна повърхност.
2. Отстранете защитния капак от безопасното заключване.
3. Натиснете бутона за безопасно заключване, за да извадите кошницата.

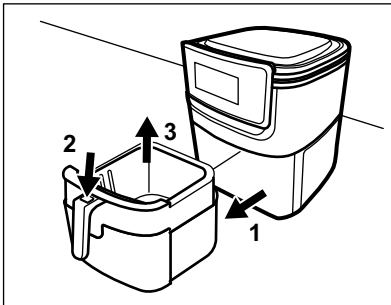



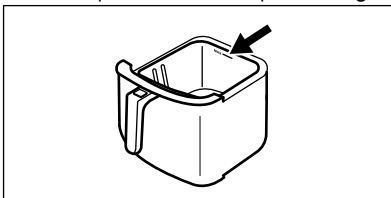





4. Поставете храната в кошницата до запълване на максималния капацитет. Максималният капацитет на кошницата е 2 kg.



4.2 Как да готвите

Поставете храната в кошницата.
Включете уреда.

1.  – докоснете и задръжте.
2. Изберете ястието от Помощ при готвене:

Символ	Настройка
	140°C 15 мин.
	200°C 10 мин.
	180°C 20 мин.
	180°C 45 мин.
	170°C 15 мин.
	180°C 15 мин.
	180°C 10 мин.
	180°C 15 мин.

3. Натиснете: .

Когато готвенето приключи, охлаждащият вентилатор работи за няколко секунди, след което се чува сигнал.

Можете да промените настройките и да изключите уреда по време на готвене:







- Натиснете символа за храна, за да смените програмата.
- \wedge , \vee – натиснете, за да регулирате настройките за час или температура.







-  – натиснете и задръжте за няколко секунди, за да изключите уреда.

Изключете уреда от контакта и изчакайте да изстине. Почистете тавата и кошницата.

5. СЪВЕТИ ЗА ГОТВЕНЕ

Температурата и времето за готвене в таблиците са само ориентировъчни. Те зависят от рецептите, качеството и количеството на използваните съставки.

	 (kg)	 (min)	 (°C)	
 Картофи и зеленчуци				
Пържени картопки, тънки, замр.	0.3 - 0.7	9 - 16	180	Разклатете кошницата
Пържени картопки, дебели, замр.	0.3 - 0.7	11 - 20	180	Разклатете кошницата
Пържени картопки (8 x 8 mm)	0.3 - 0.8	10 - 16	180	Разклатете кошницата / Добавете 1/2 супена лъжица олио
Картофи „Уеджис“, замразени	0.3 - 0.8	18 - 22	180	Разклатете кошницата / Добавете 1/2 супена лъжица олио
Кубчета картофи	0.3 - 0.75	12 - 18	180	Разклатете кошницата / Добавете 1/2 супена лъжица олио
Пълнени зеленчуци	0.1 - 0.4	10	170	-
Зеленчуци	0.1 - 0.4	10	170	-
 Месо и птиче месо				
Стек	0.1 - 0.5	8 - 12	200	-
Свински пържоли	0.1 - 0.5	10 - 14	200	-
Хамбургер	0.1 - 0.5	7 - 14	200	-
Пирожки с месо	0.1 - 0.5	13 - 15	200	-
Пилешки бутчета	0.1 - 0.5	18 - 22	180	-

	 (kg)	 (min)	 (°C)	
Пилешки гърди	0.1 - 0.5	10 - 15	185	-
Пиле	0.9 - 1.2	40 - 50	180	-
 Хапки				
Пролетни рулца, замразени	0.1 - 0.4	8 - 10	200	Разклатете кошницата
Пилешки панирани хапки, замр.	0.1 - 0.5	6 - 10	200	Разклатете кошницата
Рибни пръчици, замр.	0.1 - 0.4	6 - 10	200	-
Закуски с натрошено сирене, замразени	0.1 - 0.4	8 - 10	180	-
 Печене				
Кейкове	0.3	20 - 25	165	Използвайте тава за печене
Киш	0.4	20 - 22	185	Използвайте тава за печене / чиния за фурна
Мъфини	0.3	15 - 18	200	Използвайте тава за печене

6. БЕЛЕЖКИ ОТНОСНО ПОЧИСТВАНЕТО

	Почистващи препарати и аксесоари	Всекидневна употреба
	Почиствайте грила/тигана и кошницата с мека гъба с топла вода и измиваща течност.	Преди почистване, изключете уреда от контакта и изчакайте да изстине.
	Грилът/тиганът и кошницата са подходящи за почистване в съдомиялна.	Почиствайте уреда след всяка употреба.
	Почистете загряващия елемент с четка за почистване. Почистете с мека кърпа външната страна на уреда.	

7. КАК ДА ПОСТЪПИТЕ, АКО...

Проблем	Проверете дали...
Не можете да активирате или работите с уреда.	<ul style="list-style-type: none"> Уреда е правилно свързан към енергийно хранване. Времето за готвене е настроено.

Проблем	Проверете дали...
Не можете да поставите грила/тигана в уреда.	<ul style="list-style-type: none"> • Кошницата не е с надхвърлен максимален капацитет. • Кошницата е поставена правилно. Трябва да се чуе „щракване“, когато е поставена в грила/тигана.
От уреда излиза бял пушек.	<ul style="list-style-type: none"> • Храната, която приготвяте, не е мазна. • Грилът/тиганът и кошницата са чисти.

8. ТЕХНИЧЕСКИ ДАННИ

8.1 Технически данни

Волтаж	220 - 240 V
Честота	50 - 60 Hz

1. ALGEMEEN OVERZICHT

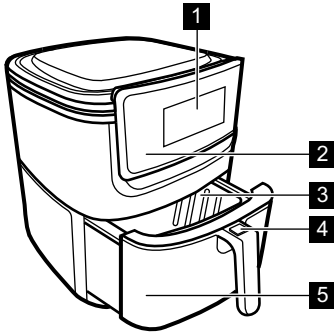

- 1** Display
- 2** Bedieningspaneel
- 3** Mand
- 4** Veiligheidsvergrendeling met beschermkap
- 5** Schaal

2. BEDIENINGSPANEEL

2.1 Bedieningspaneel

Maak uzelf vertrouwd met de basispictogrammen op het bedieningspaneel en op het display.



Kook- En Bakassistent - koken met automatische tijd- en temperatuurinstellingen.



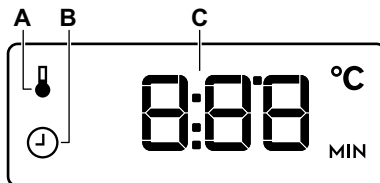

2.2 Display



- A.** Temperatuurinstelling
- B.** Tijdsinstelling
- C.** Tijd / temperatuur

3. VOORAFGAAND AAN HET EERSTE GEBRUIK

	Verwijder alle verpakkingsmateriaal, etiketten en beschermende folie.
	Reinig de mand en de pan met warm water, een afwasmiddel en een zachte doek. Droog de binnen- en buitenkant van het apparaat met een doek.
	Bij het eerste gebruik kan het product niet-giftige geurtjes afgeven, die onmiddellijk verdwijnen. Dit heeft geen invloed op het gebruik.

4. DAGELIJKS GEBRUIK

4.1 Hoe te gebruiken: pan en mand

Plaats het apparaat op het stabiele oppervlak.

1. Verwijder de pan en plaats deze op een stabiel oppervlak.
2. Verwijder de beschermkap van de veiligheidsvergrendeling.
3. Druk op de veiligheidsvergrendeling om de mand te verwijderen.

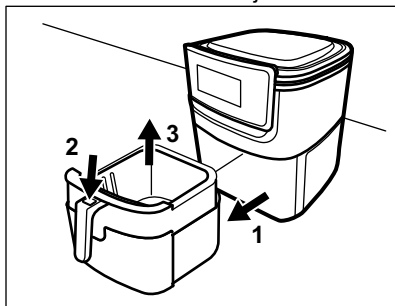

4. Plaats het voedsel in de mand tot het maximale niveau. De maximumcapaciteit van de mand is 2 kg.

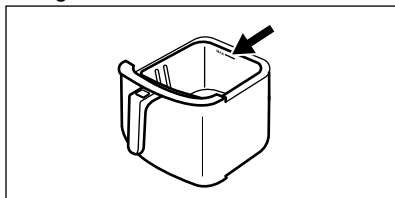

4.2 Het bereiden van voedsel

Plaats het voedsel in de mand. Steek de stekker in het stopcontact.

1.  - ingedrukt houden.
2. Selecteer het gerecht uit Kookassistentie:

Symbol	Instellingen
	140°C 15 min
	200°C 10 min
	180°C 20 min
	180°C 45 min
	170°C 15 min
	180°C 15 min
	180°C 10 min
	180°C 15 min

3. Druk op: .
Na de bereiding gaat de koelventilator gedurende enkele seconden aan, waarna het signaal klinkt.

U kunt de instellingen wijzigen en het apparaat uitschakelen tijdens de bereiding:









- Druk op het voedselsymbool om het programma te wijzigen.
- ^, v - druk hierop om de tijd- of temperatuurinstellingen aan te passen.







-  - houd deze een paar seconden ingedrukt om het apparaat uit te schakelen.

Trek de stekker van het apparaat uit het stopcontact en wacht tot het apparaat is afgekoeld. Reinig de pan en de mand.

5. BEREIDINGSTIPS

De temperatuur en kooktijden in de tabellen zijn slechts als richtlijn bedoeld. Deze zijn afhankelijk van de recepten en de kwaliteit en de hoeveelheid van de gebruikte ingrediënten.

	 (kg)	 (min)	 (°C)	
 Aardappelen en groenten				
Frietjes, dun, bevroren	0,3 - 0,7	9 - 16	180	Schud de mand
Frietjes, dik, bevroren	0,3 - 0,7	11 - 20	180	Schud de mand
Frietjes (8 x 8 mm)	0,3 - 0,8	10 - 16	180	Schud de mand / Voeg 1/2 eetlepel olie toe
Aardappelpartjes, vers	0,3 - 0,8	18 - 22	180	Schud de mand / Voeg 1/2 eetlepel olie toe
Aardappelblokjes	0,3 - 0,75	12 - 18	180	Schud de mand / Voeg 1/2 eetlepel olie toe
Gevulde groente	0,1 - 0,4	10	170	-
Groenten	0,1 - 0,4	10	170	-
 Vlees en gevogelte				
Steak	0,1 - 0,5	8 - 12	200	-
Varkenskoteletten	0,1 - 0,5	10 - 14	200	-
Hamburger	0,1 - 0,5	7- 14	200	-
Worstenbroodjes	0,1 - 0,5	13 - 15	200	-
Kippendrumsticks	0,1 - 0,5	18 - 22	180	-
Kippenborst	0,1 - 0,5	10 - 15	185	-
Kip	0,9 - 1,2	40 - 50	180	-
 Snacks				
Loempia's, bevroren	0,1 - 0,4	8 - 10	200	Schud de mand

	 (kg)	 (min)	 (°C)	
Kipnuggets, bevroren	0,1 - 0,5	6 - 10	200	Schud de mand
Vissticks, bevroren	0,1 - 0,4	6 - 10	200	-
Broodverkrumelde kaassnacks, bevroren	0,1 - 0,4	8 - 10	180	-
 Bakken				
Cakes	0,3	20 - 25	165	Gebruik een bakblik
Quiche	0,4	20 - 22	185	Gebruik een bakblik/ovenschaal
Muffins	0,3	15 - 18	200	Gebruik een bakblik

6. OPMERKINGEN OVER SCHOONMAKEN



Reinigingsmiddelen en accessoires

Reinig de pan en de mand met een zachte spons met warm water en een afwasmiddel. De pan en de mand zijn vaatwasmachinebestendig.

Reinig het verwarmingselement met een schoonmaakborsteltje.

Reinig de buitenkant van het apparaat met een zachte doek.

Dagelijks gebruik

Trek de stekker van het apparaat uit het stopcontact en wacht tot het apparaat afgekoeld is voordat u het begint te reinigen. Reinig het apparaat telkens na gebruik

7. WAT TE DOEN IN DE VOLGENDE GEVALLEN...

Probleem	Controleer of de volgende zaken gelden...
U kunt het apparaat niet inschakelen of bedienen.	<ul style="list-style-type: none"> • Het apparaat is juist op een elektrische toevoer aangesloten. • De kooktijd is ingesteld.
U kunt de pan niet in het apparaat schuiven.	<ul style="list-style-type: none"> • De mand is niet voor meer dan de maximale capaciteit gevuld. • De mand is correct geplaatst. De mand moet klikken als u deze in de pan plaatst.
Er komt witte rook uit het apparaat.	<ul style="list-style-type: none"> • Het voedsel dat u maakt is niet vettig. • De pan en de mand zijn zuiver.

8. TECHNISCHE GEGEVENS

8.1 Technische gegevens

Spanning (Voltage)	220 - 240 V
Frequentie	50 - 60 Hz



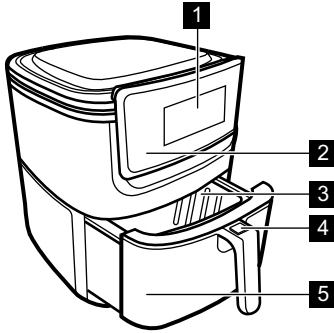









1. GENERAL OVERVIEW



- 1** Display
- 2** Control panel
- 3** Basket
- 4** Safety lock with protection cover
- 5** Pan

2. CONTROL PANEL

2.1 Control panel

Familiarize yourself with the basic icons on the control panel and on the display.				
 ON / OFF	 Up	 Down	 Temperature	 Duration
Assisted Cooking - cook with automatic time and temperature settings.				
 Fish	 Steak	 Chicken drumsticks	 Chicken	
 Vegetables	 French fries	 Mini pizza	 Muffins	

2.2 Display

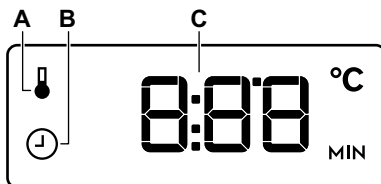

- A.** Temperature setting
- B.** Time setting
- C.** Time / temperature

3. BEFORE FIRST USE



Remove all the packaging, labelling and protective film.



Clean the basket and the pan with warm water, washing-up liquid and a soft cloth. Dry inside and outside of the appliance with a cloth.



At the first use, the product may release non-toxic odour, which disappears immediately. This does not affect the usage.

4. DAILY USE

4.1 How to use: pan and basket

Place the appliance on the stable surface.

1. Remove the pan and place it on a stable surface.
2. Remove the protection cover on the safety lock.
3. Press the safety lock to remove the basket.

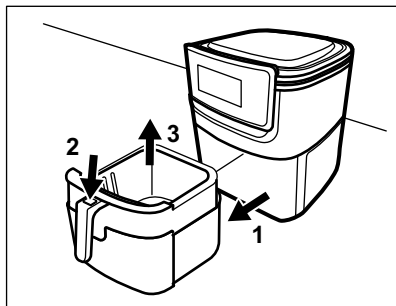

4. Put the food into the basket up to the maximum level. The maximum capacity of the basket is 2 kg.

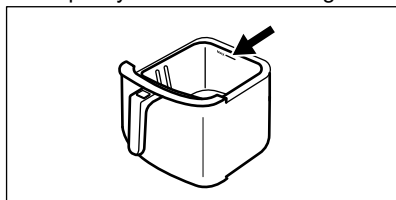

4.2 How to cook

Put the food into the basket. Plug in the appliance.

1. - press and hold.
2. Select the dish from Assisted cooking:

Symbol	Setting
	140°C 15 min
	200°C 10 min
	180°C 20 min
	180°C 45 min
	170°C 15 min
	180°C 15 min
	180°C 10 min
	180°C 15 min

3. Press: .

When the cooking ends, the cooling fan works for a few seconds, then the signal sounds.

You can change the settings and turn off the appliance during cooking:









- Press the food symbol to change the programme.
- \wedge , \vee - press to adjust time or temperature settings.







-  - press and hold for a few seconds to turn off the appliance.

Unplug the appliance and wait until it is cold. Clean the pan and the basket.

5. COOKING HINTS

The temperature and cooking times in the tables are guidelines only. They depend on the recipes and the quality and quantity of the ingredients used.

	 (kg)	 (min)	 (°C)	
 Potatoes and vegetables				
French fries, thin, frozen	0.3 - 0.7	9 - 16	180	Shake the basket
French fries, thick, frozen	0.3 - 0.7	11 - 20	180	Shake the basket
French fries (8 x 8 mm)	0.3 - 0.8	10 - 16	180	Shake the basket / Add 1/2 tablespoon of oil
Potato wedges, fresh	0.3 - 0.8	18 - 22	180	Shake the basket / Add 1/2 tablespoon of oil
Potato cubes	0.3 - 0.75	12 - 18	180	Shake the basket / Add 1/2 tablespoon of oil
Stuffed vegetables	0.1 - 0.4	10	170	-
Vegetables	0.1 - 0.4	10	170	-
 Meat and poultry				
Steak	0.1 - 0.5	8 - 12	200	-
Pork chops	0.1 - 0.5	10 - 14	200	-
Hamburger	0.1 - 0.5	7 - 14	200	-
Sausage rolls	0.1 - 0.5	13 - 15	200	-
Chicken drumsticks	0.1 - 0.5	18 - 22	180	-
Chicken breast	0.1 - 0.5	10 - 15	185	-
Chicken	0.9 - 1.2	40 - 50	180	-
 Snacks				
Spring rolls, frozen	0.1 - 0.4	8 - 10	200	Shake the basket

	 (kg)	 (min)	 (°C)	
Chicken nuggets, frozen	0.1 - 0.5	6 - 10	200	Shake the basket
Fish fingers, frozen	0.1 - 0.4	6 - 10	200	-
Bread crumbed cheese snacks, frozen	0.1 - 0.4	8 - 10	180	-
 Baking				
Cakes	0.3	20 - 25	165	Use a baking tin
Quiche	0.4	20 - 22	185	Use a baking tin / oven dish
Muffins	0.3	15 - 18	200	Use a baking tin

6. NOTES ON CLEANING

	Cleaning agents and accessories	Everyday use
	Clean the pan and the basket with a soft sponge with warm water and a washing-up liquid.	Before cleaning unplug the appliance and wait until it is cold.
	The pan and the basket are dishwasher-safe.	Clean the appliance after each use.
	Clean the heating element with a cleaning brush. Clean the outside of the appliance with a soft cloth.	

7. WHAT TO DO IF...

Problem	Check if...
You cannot activate or operate the appliance.	<ul style="list-style-type: none"> The appliance is correctly connected to an electrical supply. The cooking time is set.
You cannot slide the pan into the appliance.	<ul style="list-style-type: none"> The basket is not filled over its maximum capacity. The basket is placed correctly. It has to click when you place it in the pan.
White smoke comes out of the appliance.	<ul style="list-style-type: none"> The food you prepare is not greasy. The pan and the basket are clean.

8. TECHNICAL DATA

8.1 Technical data

Voltage	220 - 240 V
Frequency	50 - 60 Hz

1. PRÉSENTATION GÉNÉRALE

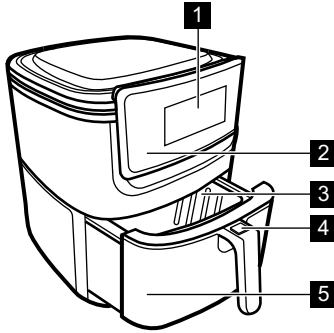

- 1** Affichage
- 2** Bandeau de commande
- 3** Panier
- 4** Verrouillage de sécurité avec couvercle de protection
- 5** Plat

2. BANDEAU DE COMMANDE

2.1 Bandeau de commande

Familiarisez-vous avec les symboles de base du bandeau de commande et de l'affichage :

MARCHE / ARRÊT	Haut	Bas	Température	Durée

Cuisson assistée - faites cuire avec les réglages automatiques de durée et de température.

Poisson	Steak	Pilons de poulet	Poulet
Légumes	Frites	Mini pizza	Muffins

2.2 Affichage

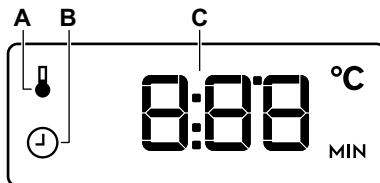

- A.** Réglage de température
- B.** Réglage de l'heure
- C.** Durée / Température

3. AVANT LA PREMIÈRE UTILISATION



Retirez les emballages, les étiquettes et les films de protection.



Nettoyez le panier et le plat avec de l'eau chaude, du liquide vaisselle et un chiffon doux.

Séchez l'intérieur et l'extérieur de l'appareil avec un chiffon.



Lors de la première utilisation, le produit peut dégager une odeur non toxique, qui disparaît immédiatement. Cela n'affecte pas l'utilisation.

4. UTILISATION QUOTIDIENNE

4.1 Comment utiliser : plat et panier

Placez l'appareil sur une surface stable.

1. Sortez le plat et placez-le sur une surface stable.
2. Retirez le couvercle de protection sur le verrouillage de sécurité.
3. Appuyez sur le verrouillage de sécurité pour retirer le panier.

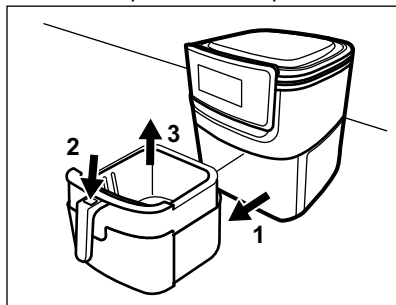

4. Placez les aliments dans le panier jusqu'au niveau maximum. Le panier a une capacité maximale de 2 kg.

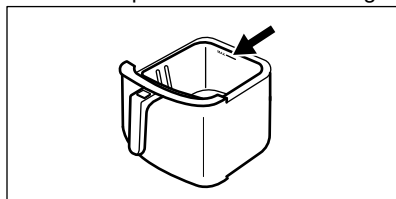

4.2 Comment cuire

Placez les aliments dans le panier. Branchez l'appareil.

1. - Maintenez la touche.

2. Sélectionnez le plat dans Cuisson assistée :

Symbole	Réglage
	140 °C 15 min
	200 °C 10 min
	180 °C 20 min
	180 °C 45 min
	170 °C 15 min
	180 °C 15 min
	180 °C 10 min
	180 °C 15 min

3. Appuyez sur : .

Lorsque la cuisson se termine, le ventilateur de refroidissement est activé pendant quelques secondes, puis le signal sonore est déclenché.

Vous pouvez modifier les réglages et mettre à l'arrêt l'appareil pendant la cuisson :









- Appuyez sur le symbole de l'aliment pour changer le programme.
- \wedge , \vee - appuyez pour ajuster les réglages de durée ou de température.







-  - appuyez et maintenez enfoncé pendant quelques secondes pour mettre à l'arrêt l'appareil.

Débranchez l'appareil et attendez qu'il soit froid. Nettoyez le plat et le panier.

5. CONSEILS DE CUISSON

Les températures et temps de cuisson se trouvant dans les tableaux ne sont indiqués qu'à titre indicatif. Ils varient en fonction des recettes ainsi que de la qualité et de la quantité des ingrédients utilisés.

	 (kg)	 (min)	 (°C)	
 Pommes de terre et légumes				
Frites, fines, surgelé	0,3 - 0,7	9 - 16	180	Secouez le panier
Frites, épaisses, surgelé	0,3 - 0,7	11 - 20	180	Secouez le panier
Frites (8 x 8 mm)	0,3 - 0,8	10 - 16	180	Secouez le panier / Ajoutez 1/2 cuillères à soupe d'huile
Quartiers de pommes de terre, frais	0,3 - 0,8	18 - 22	180	Secouez le panier / Ajoutez 1/2 cuillères à soupe d'huile
Cubes de pommes de terre	0,3 - 0,75	12 - 18	180	Secouez le panier / Ajoutez 1/2 cuillères à soupe d'huile
Légumes farcis	0,1 - 0,4	10	170	-
Légumes	0,1 - 0,4	10	170	-
 Viande et volaille				
Steak	0,1 - 0,5	8 - 12	200	-
Côtelettes de porc	0,1 - 0,5	10 - 14	200	-
Steak haché	0,1 - 0,5	7 - 14	200	-
Roulés aux saucisses	0,1 - 0,5	13 - 15	200	-
Pilons de poulet	0,1 - 0,5	18 - 22	180	-
Blanc de poulet	0,1 - 0,5	10 - 15	185	-
Poulet	0,9 - 1,2	40 - 50	180	-
 En-cas				
Rouleaux de printemps, surgelés	0,1 - 0,4	8 - 10	200	Secouez le panier

	 (kg)	 (min)	 (°C)	
Nuggets de poulet, surgelé	0,1 - 0,5	6 - 10	200	Secouez le panier
Bâtonnets de poisson, surgelé	0,1 - 0,4	6 - 10	200	-
En-cas au fromage panés, surgelés	0,1 - 0,4	8 - 10	180	-
 Cuisson				
Gâteaux	0,3	20 - 25	165	Utilisez un moule à gâteaux.
Quiche	0,4	20 - 22	185	Utilisez un moule à gâteaux / plat allant au four
Muffins	0,3	15 - 18	200	Utilisez un moule à gâteaux.

6. REMARQUES CONCERNANT L'ENTRETIEN

	Produits de nettoyage et accessoires	Utilisation quotidienne
	<p>Nettoyez le plat et le panier avec à l'aide d'une éponge douce avec de l'eau chaude et du liquide vaisselle.</p> <p>Le plat et le panier peuvent passer au lave-vaisselle.</p> <p>Nettoyez l'élément chauffant avec une brosse de nettoyage.</p> <p>Nettoyez l'extérieur de l'appareil avec un chiffon doux.</p>	<p>Avant le nettoyage, débranchez l'appareil et attendez qu'il soit froid.</p> <p>Nettoyez l'appareil après chaque utilisation.</p>

7. QUE FAIRE SI...

Problème	Vérifiez si...
Vous ne pouvez pas mettre en fonctionnement l'appareil ni le faire fonctionner.	<ul style="list-style-type: none"> • L'appareil est correctement branché à la prise électrique. • La durée de cuisson est réglée
Vous ne pouvez pas faire coulisser le plat dans l'appareil.	<ul style="list-style-type: none"> • Le panier n'est pas rempli au-delà de sa capacité maximale. • Le panier est placé correctement. Il doit s'enclencher lorsque vous le placez dans le plat.
De la fumée blanche sort de l'appareil.	<ul style="list-style-type: none"> • Les aliments que vous préparez ne sont pas gras. • Le plat et le panier sont propres.

8. CARACTÉRISTIQUES TECHNIQUES

8.1 Caractéristiques techniques

Tension	220 - 240 V
Fréquence	50 - 60 Hz

1. GESAMTANSICHT

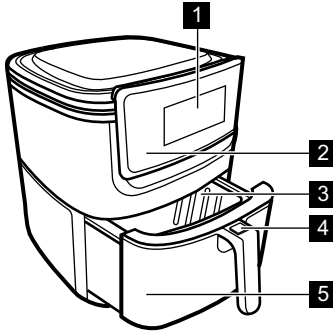

- 1** Display
- 2** Bedienfeld
- 3** Korb
- 4** Sicherheitsverriegelung mit Schutzabdeckung
- 5** Gar-Behälter

2. BEDIENFELD

2.1 Bedienfeld

Machen Sie sich mit den grundlegenden Symbolen auf dem Bedienfeld und auf dem Display vertraut.

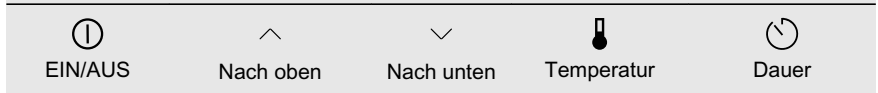

Koch-Assistent - Kochen mit automatischen Zeit- und Temperatureinstellungen.

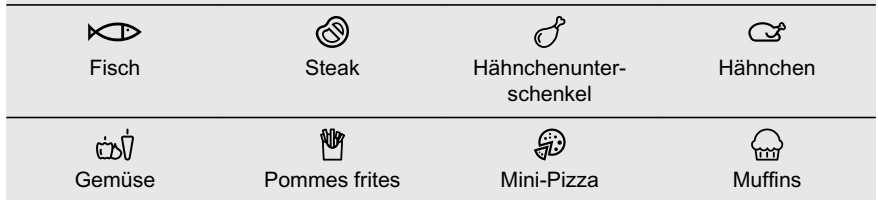

2.2 Display

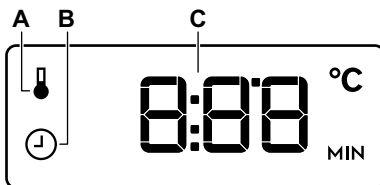

- A.** Temperatureinstellung
- B.** Zeiteinstellung
- C.** Zeit/Temperatur

3. VOR DER ERSTEN VERWENDUNG



Entfernen Sie die gesamte Verpackung, Kennzeichnung und Schutzfolie.



Feuchten Sie ein weiches Tuch mit warmem Wasser und etwas Spülmittel an und reinigen Sie damit den Korb und den Gar-Behälter. Trocknen Sie das Gerät innen und außen mit einem Tuch ab.



Bei der ersten Verwendung kann das Produkt unangenehmen Geruch freisetzen, der aber sofort verschwindet. Dies hat keine Auswirkung auf die Nutzung.

4. TÄGLICHER GEBRAUCH

4.1 Verwendung: Gar-Behälter und Korb

Stellen Sie das Gerät auf eine stabile Oberfläche.

1. Nehmen Sie den Gar-Behälter heraus und stellen Sie ihn auf eine stabile Oberfläche.
2. Entfernen Sie die Schutzabdeckung und die Sicherheitsverriegelung.
3. Drücken Sie auf die Sicherheitsverriegelung, um den Korb zu entfernen.

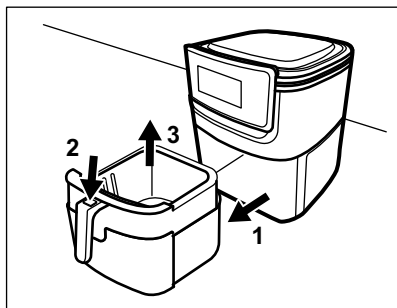



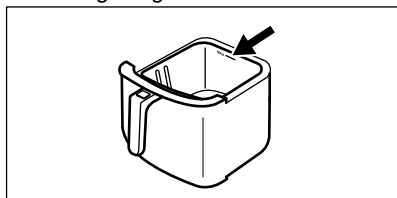





4. Füllen Sie die Zutaten in den Korb bis zur Höchstgrenze. Das maximale Fassungsvermögen des Korbs beträgt 2 kg.



4.2 So wird gekocht

Füllen Sie die Zutaten in den Korb. Schließen Sie das Gerät ans Stromnetz an.

1. Halten Sie  gedrückt.
2. Wählen Sie das Gericht im Koch-Assistenten:

Symbol	Einstellung
	140 °C 15 Min.
	200 °C 10 Min.
	180 °C 20 Min.
	180 °C 45 Min.
	170 °C 15 Min.
	180 °C 15 Min.
	180 °C 10 Min.
	180 °C 15 Min.

3. Drücken Sie: .

Nach Beendigung des Kochvorgangs läuft das Kühlgebläse einige Sekunden lang, dann ertönt das Signal.

Sie können die Einstellungen während des Garvorgangs ändern und das Gerät ausschalten:







- Drücken Sie auf das Speisensymbol, um das Programm zu ändern.
- Drücken Sie \wedge , \vee , um die Zeit- oder Temperatureinstellungen zu ändern.







- Halten Sie ⏸ einige Sekunden gedrückt, um das Gerät auszuschalten.

Ziehen Sie den Netzstecker und warten Sie, bis das Gerät kalt ist. Reinigen Sie den Gar-Behälter und den Korb.

5. GAREMPFEHLUNGEN

Die Temperaturen und Garzeiten in den Tabellen sind nur Richtwerte. Sie sind abhängig von den Rezepten, der Qualität und der Menge der verwendeten Zutaten.

	 (kg)	 (Min.)	 (°C)	
 Kartoffeln und Gemüse				
Pommes frites, dünn, gefroren	0.3 - 0.7	9 - 16	180	Schütteln Sie den Korb
Pommes frites, dick, gefroren	0.3 - 0.7	11 - 20	180	Schütteln Sie den Korb
Pommes frites (8 x 8 mm)	0.3 - 0.8	10 - 16	180	Schütteln Sie den Korb/Fügen Sie 1/2 Esslöffel Öl hinzu
Kartoffelspalten, frisch	0.3 - 0.8	18 - 22	180	Schütteln Sie den Korb/Fügen Sie 1/2 Esslöffel Öl hinzu
Kartoffelwürfel	0.3 - 0.75	12 - 18	180	Schütteln Sie den Korb/Fügen Sie 1/2 Esslöffel Öl hinzu
Gefülltes Gemüse	0.1 - 0.4	10	170	-
Gemüse	0.1 - 0.4	10	170	-
 Fleisch und Geflügel				
Steak	0.1 - 0.5	8 - 12	200	-
Schweinekoteletts	0.1 - 0.5	10 - 14	200	-
Hamburger	0.1 - 0.5	7 - 14	200	-
Würstchen im Teig	0.1 - 0.5	13 - 15	200	-
Hähnchenunterschenkel	0.1 - 0.5	18 - 22	180	-
Hähnchenbrust	0.1 - 0.5	10 - 15	185	-
Hähnchen	0.9 - 1.2	40 - 50	180	-

	 (kg)	 (Min.)	 (°C)	
 Snacks				
Frühlingsrollen, gefroren	0.1 - 0.4	8 - 10	200	Schütteln Sie den Korb
Chicken Nuggets, gefroren	0.1 - 0.5	6 - 10	200	Schütteln Sie den Korb
Fischstäbchen, gefroren	0.1 - 0.4	6 - 10	200	-
Panierte Käse-Snacks, gefroren	0.1 - 0.4	8 - 10	180	-
 Backen				
Kuchen	0.3	20 - 25	165	Verwenden Sie eine Backform
Quiche	0.4	20 - 22	185	Verwenden Sie eine Backform/Auflaufform
Muffins	0.3	15 - 18	200	Verwenden Sie eine Backform

6. HINWEISE ZUR REINIGUNG

 <p>Reinigungsmittel und Zubehör Feuchten Sie einen weichen Schwamm mit warmem Wasser und etwas Spülmittel an und reinigen Sie damit den Gar-Behälter und Korb. Der Gar-Behälter und der Korb sind spülmaschinenfest. Reinigen Sie das Heizelement mit einer Reinigungsbürste. Reinigen Sie die Außenseite des Geräts mit einem weichen Tuch.</p>	<p>Täglicher Gebrauch Ziehen Sie vor der Reinigung den Netzstecker und warten Sie, bis das Gerät kalt ist. Reinigen Sie das Gerät nach jedem Gebrauch.</p>
--	---

7. WAS TUN, WENN...

Störung	Prüfen Sie, ob...
Das Gerät kann nicht eingeschaltet oder bedient werden.	<ul style="list-style-type: none"> • Das Gerät ordnungsgemäß an die Spannungsversorgung angeschlossen ist. • Die Garzeit eingestellt ist.
Sie können den Gar-Behälter nicht in das Gerät schieben.	<ul style="list-style-type: none"> • Der Korb über sein maximales Fassungsvermögen gefüllt ist. • Der Korb richtig eingesetzt ist. Es muss klicken, wenn Sie ihn in den Gar-Behälter einsetzen.

Störung	Prüfen Sie, ob...
Weißer Rauch tritt aus dem Gerät aus.	<ul style="list-style-type: none">• Die von Ihnen zubereitete Speise fettig ist.• Der Gar-Behälter und der Korb sauber sind.

8. TECHNISCHE DATEN

8.1 Technische Daten

Spannung	220 - 240 V
Frequenz	50 - 60 Hz

1. ΓΕΝΙΚΉ ΕΠΙΣΚΟΠΗΣΗ

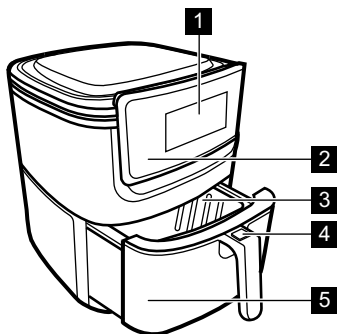





- 1** Οθόνη
- 2** Πίνακας χειριστηρίων
- 3** Καλάθι
- 4** Κλειδαριά ασφαλείας με προστατευτικό κάλυμμα
- 5** Ταψί

2. ΠΙΝΑΚΑΣ ΧΕΙΡΙΣΤΗΡΙΩΝ

2.1 Πίνακας χειριστηρίων

Εξοικειωθείτε με τα βασικά εικονίδια στο χειριστήριο και στην οθόνη.

 ΕΝΑΡΞΗ / ΛΗ-ΞΗ	 Επάνω	 Κάτω	 Θερμοκρασία	 Διάρκεια
---	--	---	--	---

Μαγείρεμα με βοήθεια - μαγείρεμα με αυτόματες ρυθμίσεις χρόνου και θερμοκρασίας.

 Ψάρι	 Μπιριζόλα	 Μπουτία από κοτό-πουλο	 Κοτόπουλο
 Λαχανικά	 Τηγανιτές πατάτες	 Μίνι πίτσα	 Κέικ Muffins

2.2 Οθόνη

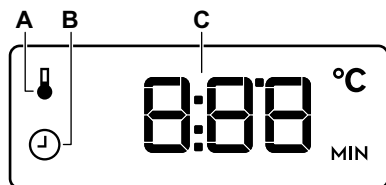

- A.** Ρύθμιση θερμοκρασίας
- B.** Ρύθμιση χρόνου
- C.** Χρόνος / θερμοκρασία

3. ΠΡΙΝ ΤΗΝ ΠΡΩΤΗ ΧΡΗΣΗ



Αφαιρέστε όλα τα υλικά συσκευασίας, τις ετικέτες και την προστατευτική μεμβράνη.



Καθαρίστε το καλάθι και το ταψί με χλιαρό νερό, υγρό απορρυπαντικό πιάτων και ένα μαλακό πανί.

Στεγνώστε το εσωτερικό και το εξωτερικό μέρος της συσκευής με ένα πανί.



Στην πρώτη χρήση, ενδέχεται να απελευθερωθεί μία μη τοξική μυρωδιά, η οποία εξαφανίζεται αμέσως. Αυτό δεν επηρεάζει την χρήση.

4. ΚΑΘΗΜΕΡΙΝΉ ΧΡΗΣΗ

4.1 Τρόπος χρήσης: ταψί και καλάθι

Τοποθετήστε τη συσκευή σε μια σταθερή επιφάνεια.

1. Αφαιρέστε το ταψί και τοποθετήστε το σε μια σταθερή επιφάνεια.
2. Αφαιρέστε το προστατευτικό κάλυμμα από την κλειδαριά ασφαλείας.
3. Πιέστε την κλειδαριά ασφαλείας για να αφαιρέσετε το καλάθι.

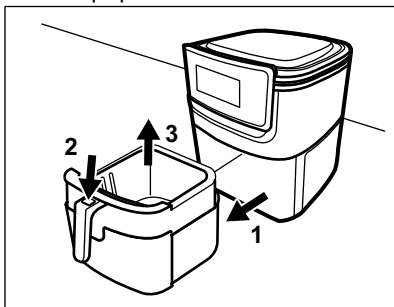

4. Τοποθετήστε το φαγητό μέσα στο καλάθι μέχρι το μέγιστο επίπεδο. Η μέγιστη χωρητικότητα του καλάθιού είναι 2 kg.

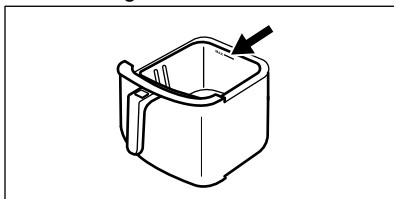

4.2 Τρόπος μαγειρέματος

Τοποθετήστε το φαγητό στο καλάθι. Βάλτε την συσκευή στην πρίζα.

1. - πιέστε παρατεταμένα.
2. Επιλέξτε το φαγητό από το Μαγείρεμα με βοήθεια:

Σύμβολο	Ρύθμιση:
	140°C 15 ΛΕΠ.
	200°C 10 ΛΕΠ.
	180°C 20 ΛΕΠ.
	180°C 45 ΛΕΠ.
	170°C 15 ΛΕΠ.
	180°C 15 ΛΕΠ.
	180°C 10 ΛΕΠ.
	180°C 15 ΛΕΠ.

3. Πιέστε: .

Όταν τελειώσει το μαγείρεμα, ο ανεμιστήρας ψύξης λειτουργεί για μερικά δευτερόλεπτα, έπειτα ακούγεται το ηχητικό σήμα.

Μπορείτε να αλλάξετε τις ρυθμίσεις και να απενεργοποιήσετε τη συσκευή κατά το μαγείρεμα:









- Πιέστε το σύμβολο φαγητού για να αλλάξετε το πρόγραμμα.
- \wedge , \vee - πιέστε για να προσαρμόσετε τις ρυθμίσεις χρόνου ή θερμοκρασίας.







- ⌚ - πιέστε παρατεταμένα για μερικά δευτερόλεπτα για να απενεργοποιήσετε τη συσκευή.

Αποσυνδέστε τη συσκευή από την πρίζα και περιμένετε μέχρι να κρυώσει. Καθαρίστε το ταψί και το καλάθι.

5. ΣΥΜΒΟΥΛΕΣ ΜΑΓΕΙΡΕΜΑΤΟΣ

Οι τιμές θερμοκρασίας και χρόνου μαγειρέματος στους πίνακες είναι μόνο ενδεικτικές. Εξαρτώνται από τις συνταγές, καθώς και από την ποιότητα και ποσότητα των υλικών που χρησιμοποιούνται.

	 (kg)	 (λεπ.)	 (°C)	
 Πατάτες και λαχανικά				
Τηγανιτές πατάτες, λεπές, κατεψυγμ.	0.3 - 0.7	9 - 16	180	Ανακινήστε το καλάθι
Τηγ. πατάτες, χοντρ., κατεψυγμ.	0.3 - 0.7	11 - 20	180	Ανακινήστε το καλάθι
Τηγανιτές πατάτες (8 x 8 mm)	0.3 - 0.8	10 - 16	180	Ανακινήστε το καλάθι / Προσθέστε 1/2 κουταλιά λάδι
Πατάτες κυδωνάτες, φρέσκες	0.3 - 0.8	18 - 22	180	Ανακινήστε το καλάθι / Προσθέστε 1/2 κουταλιά λάδι
Κύβοι πατάτας	0.3 - 0.75	12 - 18	180	Ανακινήστε το καλάθι / Προσθέστε 1/2 κουταλιά λάδι
Γεμιστά λαχανικά	0.1 - 0.4	10	170	-
Λαχανικά	0.1 - 0.4	10	170	-
 Κρέας και πουλερικά				
Μπριζόλα	0.1 - 0.5	8 - 12	200	-
Χοιρινές μπριζόλες	0.1 - 0.5	10 - 14	200	-
Μπιφτέκι	0.1 - 0.5	7- 14	200	-
Λουκανικόπιτες	0.1 - 0.5	13 - 15	200	-
Μπούτια από κοτόπουλο	0.1 - 0.5	18 - 22	180	-
Στήθος κοτόπουλου	0.1 - 0.5	10 - 15	185	-
Κοτόπουλο	0.9 - 1.2	40 - 50	180	-
 Σνακ				

	 (kg)	 (ΛΕΠ.)	 (°C)	
Σπρινγκ ρολς, κατεψυγμένα	0.1 - 0.4	8 - 10	200	Ανακινήστε το καλάθι
Μπουκιές κοτόπουλου, κατεψυγμ.	0.1 - 0.5	6 - 10	200	Ανακινήστε το καλάθι
Μπουκίτσες ψαριού, κατεψυγμ.	0.1 - 0.4	6 - 10	200	-
Τυροκρόκετες πανέ, κατεψυγμ.	0.1 - 0.4	8 - 10	180	-
 Ψήσιμο				
Κέικ	0.3	20 - 25	165	Χρησιμοποιήστε φόρμα ψησίματος
Κις	0.4	20 - 22	185	Χρησιμοποιήστε φόρμα / σκεύος ψησίματος
Κέικ Muffins	0.3	15 - 18	200	Χρησιμοποιήστε φόρμα ψησίματος

6. ΣΗΜΕΙΩΣΕΙΣ ΓΙΑ ΤΟΝ ΚΑΘΑΡΙΣΜΟ

	<p>Καθαριστικά προϊόντα και εξαρτήματα Καθαρίστε το ταψί και το καλάθι με ένα μαλακό σφουγγάρι με χλιαρό νερό και απορρυπαντικό πιάτων. Το ταψί και το καλάθι είναι κατάλληλα για πλύσιμο στο πλυντήριο πιάτων. Καθαρίστε την αντίσταση με μια βούρτσα καθαρισμού. Καθαρίστε το εξωτερικό μέρος της συσκευής με ένα μαλακό πανί.</p>	<p>Καθημερινή χρήση Πριν από τον καθαρισμό, αποσυνδέστε τη συσκευή και περιμένετε να κρυώσει. Καθαρίζετε τη συσκευή μετά από κάθε χρήση.</p>
--	---	---

7. ΤΙ ΝΑ ΚΑΝΕΤΕ ΑΝ...

Πρόβλημα	Ελέγξτε εάν...
Δεν μπορείτε να ενεργοποιήσετε ή να λειτουργήσετε τη συσκευή.	<ul style="list-style-type: none"> • Η συσκευή είναι σωστά συνδεδεμένη στην ηλεκτρική παροχή. • Ο χρόνος μαγειρέματος είναι ρυθμισμένος.

Πρόβλημα	Ελέγξτε εάν...
Δεν μπορείτε να τοποθετήσετε το ταψί μέσα στη συσκευή.	<ul style="list-style-type: none"> • Το καλάθι είναι γεμάτο πέρα από τη μέγιστη χωρητικότητά του. • Το καλάθι είναι τοποθετημένο σωστά. Πρέπει να κουμπώσει όταν το τοποθετείτε μέσα στο ταψί.
Αναδύεται λευκός καπνός από τη συσκευή.	<ul style="list-style-type: none"> • Το φαγητό που μαγειρεύετε είναι λιπαρό. • Το ταψί και το καλάθι είναι καθαρά.

8. ΤΕΧΝΙΚΑ ΧΑΡΑΚΤΗΡΙΣΤΙΚΑ

8.1 Τεχνικά χαρακτηριστικά

Τάση	220 - 240 V
Συχνότητα	50 - 60 Hz

1. VISÃO GERAL

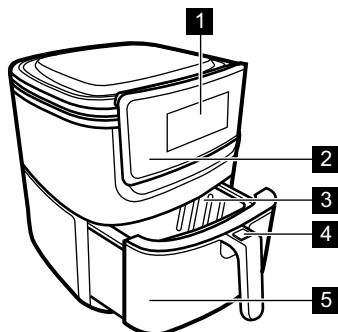

- 1** Visor
- 2** Painel de controlo
- 3** Cesto
- 4** Fecho de segurança com tampa de proteção
- 5** Recipiente

2. PAINEL DE COMANDOS

2.1 Painel de controlo

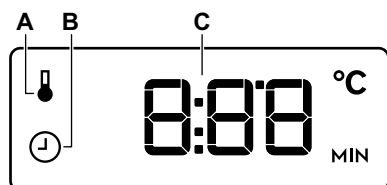

Familiarize-se com os ícones básicos no painel de controlo e no visor.				
ON / OFF	Subir	Descer	Temperatura	Duração
Cozedura assistida - cozinhe com definições automáticas de tempo e temperatura.				
Peixe	Bife	Coxas de frango	Frango	
Legumes	Batatas fritas	Mini pizza	Queques	

2.2 Visor



- A.** Regulação da temperatura
- B.** Definir as horas
- C.** Tempo/Temperatura

3. BEFORE FIRST USE

	Retire todas as películas de embalagem, rotulagem e de proteção.
	Limpe o cesto e o recipiente com água morna, detergente da loiça e um pano macio. Seque o interior e o exterior do aparelho com um pano.
	Na primeira utilização, o produto pode libertar odores não tóxicos, que desaparecem de imediato. Isso não afeta a utilização.

4. UTILIZAÇÃO DIÁRIA

4.1 Como utilizar: recipiente e cesto

Coloque o aparelho numa superfície estável.

1. Retire o recipiente e coloque-o numa superfície estável.
2. Retire a tampa de proteção no fecho de segurança.
3. Prima o fecho de segurança para retirar o cesto.

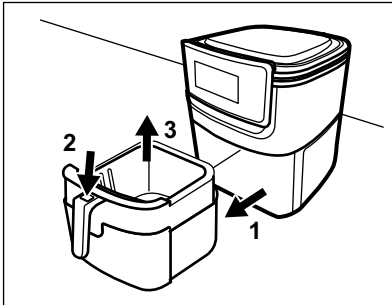



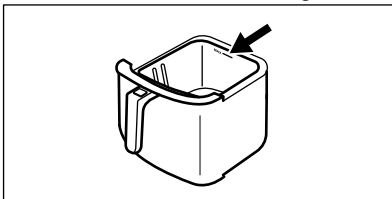





4. Coloque os alimentos no cesto até ao nível máximo. A capacidade máxima do cesto é de 2 kg.



4.2 Como cozinhar

Coloque os alimentos no cesto. Ligue o aparelho.

1.  - mantenha premido.
2. Selecione o prato da cozedura assistida:

Símbolo	Definição
	140 °C 15 min
	200 °C 10 min
	180 °C 20 min
	180 °C 45 min
	170 °C 15 min
	180 °C 15 min
	180 °C 10 min
	180 °C 15 min

3. Premir: .
Quando a cozedura estiver concluída, a ventoinha de arrefecimento funciona durante alguns segundos, após o qual é emitido um sinal sonoro.

Pode alterar as definições e desligar o aparelho durante a cozedura:









- Prima o símbolo do alimento para alterar o programa.
- \wedge , \vee - prima para ajustar o tempo ou as definições da temperatura.







-  - mantenha premido durante alguns segundos para desligar o aparelho.

Desligue o aparelho e aguarde até que esteja frio. Limpe o recipiente e o cesto.

5. SUGESTÕES DE COZEDURA

A temperatura e os tempos de cozedura indicados nas tabelas são apenas valores de referência. Dependem das receitas, da qualidade e da quantidade dos ingredientes utilizados.

	 (kg)	 (min)	 (°C)	
 Batatas e legumes				
Batatas fritas, finas congelados	0,3 - 0,7	9 - 16	180	Agite o cesto
Batatas fritas, grossas congelados	0,3 - 0,7	11 - 20	180	Agite o cesto
Batatas fritas (8 x 8 mm)	0,3 - 0,8	10 - 16	180	Agite o cesto/Adicione 1/2 colher de sopa de óleo
Fatias de batata, frescas	0,3 - 0,8	18 - 22	180	Agite o cesto/Adicione 1/2 colher de sopa de óleo
Batata em cubos	0,3 - 0,75	12 - 18	180	Agite o cesto/Adicione 1/2 colher de sopa de óleo
Legumes recheados	0,1 - 0,4	10	170	-
Legumes	0,1 - 0,4	10	170	-
 Carne e aves				
Bife	0,1 - 0,5	8 - 12	200	-
Costeleta de porco	0,1 - 0,5	10 - 14	200	-
Hamburguer	0,1 - 0,5	7 - 14	200	-
Rolinhos de salsicha	0,1 - 0,5	13 - 15	200	-
Coxas de frango	0,1 - 0,5	18 - 22	180	-
Peito de frango	0,1 - 0,5	10 - 15	185	-
Frango	0,9 - 1,2	40 - 50	180	-
 Snacks				
Pastéis, congelados	0,1 - 0,4	8 - 10	200	Agite o cesto

	 (kg)	 (min)	 (°C)	
Frangocongelados	0,1 - 0,5	6 - 10	200	Agite o cesto
Barrinhas de peixecongelados	0,1 - 0,4	6 - 10	200	-
Snacks de queijo com pão ralado, congelados	0,1 - 0,4	8 - 10	180	-
 Bolos				
Bolos	0,3	20 - 25	165	Utilize um tabuleiro para assar
Quiche	0,4	20 - 22	185	Utilize um tabuleiro para assar/prato de forno
Queques	0,3	15 - 18	200	Utilize um tabuleiro para assar

6. NOTAS SOBRE A LIMPEZA

	Agentes de limpeza e acessórios	Utilização diária
	<p>Limpe o recipiente e o cesto com uma esponja macia com água morna e um líquido de limpeza.</p> <p>O recipiente e o cesto podem ser lavados na máquina de lavar loiça.</p> <p>Limpe o elemento de calor com uma escova de limpeza.</p> <p>Limpe o exterior do aparelho com um pano macio.</p>	<p>Antes de limpar, desligue o aparelho e aguarde que arrefeça.</p> <p>Limpe o aparelho após cada utilização.</p>

7. O QUE FAZER SE...

Problema	Verifique se...
Não consegue ativar ou utilizar o aparelho.	<ul style="list-style-type: none"> • O aparelho está ligado corretamente a uma alimentação eléctrica. • O tempo de cozedura está definido.
Não consegue deslizar o recipiente no aparelho.	<ul style="list-style-type: none"> • O cesto não está cheio acima da sua capacidade máxima. • O cesto está colocado corretamente. Tem de emitir um clique quando o coloca no recipiente.
Sai fumo branco do aparelho.	<ul style="list-style-type: none"> • Os alimentos que prepara não são gordurosos. • O recipiente e o cesto estão limpos.

8. DADOS TÉCNICOS

8.1 Dados técnicos

Tensão	220 - 240 V
Frequência	50 - 60 Hz

1. DESCRIPCIÓN GENERAL

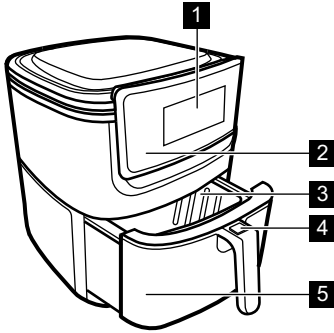

- 1 Pantalla
- 2 Panel de control
- 3 Cesta
- 4 Cierre de seguridad con cubierta de protección
- 5 Bandeja

2. PANEL DE MANDOS

2.1 Panel de control

Familiarícese con los iconos básicos del panel de control y la pantalla.

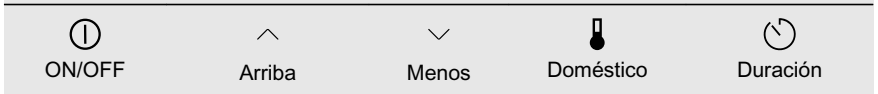

Cocción asistida - cocinar con ajustes automáticos de tiempo y temperatura.



2.2 Pantalla

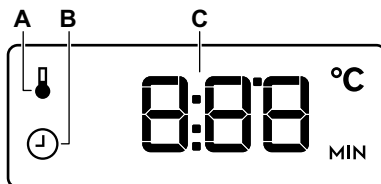

- A. Ajuste de la temperatura
- B. Ajuste de la hora
- C. Tiempo / temperatura

3. ANTES DEL PRIMER USO



Retire todo el embalaje, las etiquetas y la película protectora.



Limpie el cesto y la bandeja con agua caliente, detergente y un paño suave. Seque el interior y el exterior del aparato con un paño.



Durante el primer uso, el producto puede liberar olores no tóxicos, que desaparecerán de inmediato. Esto no afectará la utilización del electrodoméstico.

4. USO DIARIO

4.1 Instrucciones de uso: bandeja y cesta

Coloque el aparato en la superficie estable.

1. Retire la bandeja y colóquela en una superficie estable.
2. Retire la cubierta de protección del cierre de seguridad.
3. Presione el cierre de seguridad para retirar la cesta.

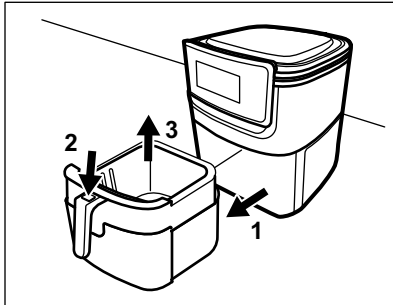

4. Ponga la comida en el cesta hasta el nivel máximo. La capacidad máxima de la cesta es de 2 kg.

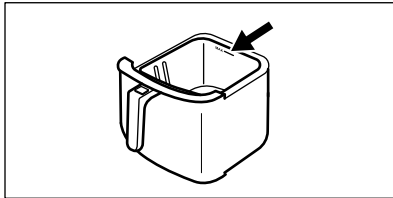

4.2 Cómo cocinar

Coloque la comida en la cesta. Conecte el aparato.

1. - mantenga pulsado.
2. Seleccione el plato en Cocción asistida:

Símbolo	Ajuste
	140 °C 15 minutos
	200 °C 10 minutos
	180 °C 20 minutos
	180 °C 45 minutos
	170 °C 15 minutos
	180 °C 15 minutos
	180 °C 10 minutos
	180 °C 15 minutos

3. Pulse: .

Cuando termina la cocción, el ventilador de refrigeración funciona durante unos segundos, luego suena la señal.

Puede cambiar los ajustes y apagar el aparato durante la cocción:









- Pulse el símbolo del alimento para cambiar el programa.
- ^, v - pulse para ajustar la hora o la temperatura.







-  - mantenga pulsado durante unos segundos para apagar el aparato.

Desenchufe el aparato y espere hasta que esté frío. Limpie la bandeja y la cesta.

5. CONSEJOS DE COCCIÓN

La temperatura y los tiempos de cocción de las tablas son meramente orientativos. Dependen de la receta, la calidad y la cantidad de los ingredientes utilizados en cada caso.

	 (kg)	 (min)	 (°C)	
 Patatas y verduras				
Patatas fritas finas, congelada	0.3 - 0.7	9 - 16	180	Agite la cesta
Patatas fritas gruesas, congelada	0.3 - 0.7	11 - 20	180	Agite la cesta
Patatas fritas (8 x 8 mm)	0.3 - 0.8	10 - 16	180	Agitar la cesta / Añadir 1/2 cucharada de aceite
Patatas en porciones, frescas	0.3 - 0.8	18 - 22	180	Agitar la cesta / Añadir 1/2 cucharada de aceite
Dados de patata	0.3 - 0.75	12 - 18	180	Agitar la cesta / Añadir 1/2 cucharada de aceite
Verduras rellenas	0.1 - 0.4	10	170	-
Verduras	0.1 - 0.4	10	170	-
 Carne y aves				
Bistecs	0.1 - 0.5	8 - 12	200	-
Chuletas de cerdo	0.1 - 0.5	10 - 14	200	-
Hamburguesa	0.1 - 0.5	7- 14	200	-
Pasteles de carne	0.1 - 0.5	13 - 15	200	-
Muslos de pollo	0.1 - 0.5	18 - 22	180	-
Pechuga de pollo	0.1 - 0.5	10 - 15	185	-
Pollo	0.9 - 1.2	40 - 50	180	-
 Snacks				
Rollitos de primavera, congelados	0.1 - 0.4	8 - 10	200	Agite la cesta

	 (kg)	 (min)	 (°C)	
Nuggets de pollo, congelada	0.1 - 0.5	6 - 10	200	Agite la cesta
Barritas de pescado, congelada	0.1 - 0.4	6 - 10	200	-
Bocaditos queso empanados, congelados	0.1 - 0.4	8 - 10	180	-
 Horneado				
Repostería	0.3	20 - 25	165	Use un molde de hornear
Quiche	0.4	20 - 22	185	Use un molde de hornear / fuente de horno
Muffins	0.3	15 - 18	200	Use un molde de hornear

6. NOTAS SOBRE LA LIMPIEZA

	<p>Agentes de limpieza y accesorios</p> <p>Limpie la bandeja y la cesta con una esponja suave con agua tibia y un líquido lavavajillas. La bandeja y la cesta son aptas para el lavavajillas.</p> <p>Limpie la resistencia con un cepillo de limpieza.</p> <p>Limpie el exterior del aparato con un paño suave.</p>	<p>Uso diario</p> <p>Antes de limpiar, desenchufe el aparato y espere hasta que esté frío.</p> <p>Limpie el aparato después de cada uso.</p>
---	--	---







7. QUÉ HACER SI...

Problema	Compruebe que...
El aparato no se enciende o no funciona.	<ul style="list-style-type: none"> • El aparato está bien conectado a la red eléctrica. • El tiempo de cocción está fijado.
No puede deslizar la bandeja en el aparato.	<ul style="list-style-type: none"> • La cesta no se llena por encima de su capacidad máxima. • La cesta está colocada correctamente. Tiene que hacer clic cuando se pones en la bandeja.
Sale humo blanco del aparato.	<ul style="list-style-type: none"> • La comida que prepara no es grasa. • La bandeja y la cesta están limpias.

8. DATOS TÉCNICOS

8.1 Datos técnicos

Voltaje	220 - 240 V
Frecuencia	50 - 60 Hz

		 (درجة مئوية)	 (دقيقة)	 (كجم)	
	-	180	10 - 8	0.4 - 0.1	وجبات خفيفة من الجبن المفروم، مجمد
					 مخبوزات
	استخدام صينية الخبز	165	25 - 20	0.3	كعكات
	استخدام صينية الخبز / صينية تجميصة	185	22 - 20	0.4	فطائر محشوة
	استخدام صينية الخبز	200	18 - 15	0.3	المافين

6. ملاحظات على التنظيف

الاستخدام اليومي	مركبات وملحقات التنظيف
قبل التنظيف، افصل قابس الجهاز وانتظر إلى أن يبرد. نظف الجهاز بعد كل مرة تقوم فيها باستخدام الجهاز.	نظف المقلاة والسلة بالماء الدافئ ووسائل الغسيل وقطعة إسفنج ناعمة. من الآمن وضع المقلاة والسلة في غسالة الأطباق. قم بتنظيف عنصر التسخين باستخدام فرشاة تنظيف. قم بتنظيف الجهاز من الخارج بقماش ناعمة.



7. ماذا تفعل لو...

المشكلة	تحقق مما يلي...
يتعذر عليك تشغيل أو تشغيل الجهاز.	<ul style="list-style-type: none"> الجهاز موصل بالتيار الكهربائي بشكل صحيح. وقت الطهي مضبوط.
يتعذر عليك إدخال المقلاة في الجهاز.	<ul style="list-style-type: none"> السلة غير ممثلة لأكثر من سعتها القصوى. السلة موضوعة بالشكل الصحيح. يجب أن تصدر صوت طقطقة عندما تضعها في المقلاة.
دخان أبيض يخرج من الجهاز.	<ul style="list-style-type: none"> الطعام الذي تحضره غير مدهون بالزيت. المقلاة والسلة نظيفتان.

8. البيانات الفنية

8.1 البيانات الفنية

الجهد الكهربائي	220 - 240 فولت
التردد	50 - 60 هرتز



أفضل قابس الجهاز وانتظر إلى أن يبرد. نظّف المقلاة والسلة.

5. تلميح الطهي

إعدادات درجة الحرارة ومدة الطهي الموضحة في الجداول هي إعدادات إرشادية فقط. وهي تعتمد على الوصفات وعلى نوعية المقادير المستخدمة وكمياتها.

	 (درجة مئوية)	 (دقيقة)	 (كجم)	
 البطاطس والخضروات				
	180	16 - 9	0.7 - 0.3	بطاطس مقلية، ريفية، مجمد
	180	20 - 11	0.7 - 0.3	بطاطس مقلية، سمكية، مجمد
	180	16 - 10	0.8 - 0.3	بطاطس مقلية (8 x 8 مم)
	180	22 - 18	0.8 - 0.3	قطع بطاطا محشوة، طازجة
	180	18 - 12	- 0.3 0.75	مكعبات بطاطس
	170	10	0.4 - 0.1	خضروات محشية
	170	10	0.4 - 0.1	خضراوات
 اللحوم والدواجن				
	200	12 - 8	0.5 - 0.1	شرائح اللحم
	200	14 - 10	0.5 - 0.1	قطع لحم الخنزير
	200	14 - 7	0.5 - 0.1	هامبورجر
	200	15 - 13	0.5 - 0.1	لفائف السجق
	180	22 - 18	0.5 - 0.1	أوراك الدجاج
	185	15 - 10	0.5 - 0.1	صدور الدجاج
	180	50 - 40	1.2 - 0.9	دجاج
 وجبات خفيفة				
	200	10 - 8	0.4 - 0.1	سبرنج رول، مجمدة
	200	10 - 6	0.5 - 0.1	كتل دجاج صلبة، مجمد
	200	10 - 6	0.4 - 0.1	أصابع سمك، مجمد

3. قبل الاستخدام للمرة الأولى

قم بإزالة جميع محتويات العبوة وبطاقات البيانات والغشاء الواقي.	
قم بتنظيف السلة والمقلاة بالماء الدافئ وسائل الغسيل وقطعة قماش ناعمة. جفف الجهاز من الداخل والخارج مستخدماً قطعة قماش.	
بعد الاستخدام الأول، قد تنطلق من المنتج رائحة غير سامة تختفي على الفور. وهذا لا يؤثر على الاستخدام.	①

4. الاستخدام اليومي

4.1 كيفية الاستخدام: المقلاة والسلة

ضع الجهاز على السطح المستقر.

1. أخرج المقلاة وضعها على السطح المستقر.
2. قم بإزالة غطاء الحماية الموجود على قفل الأمان.
3. اضغط على قفل الأمان لفك السلة.

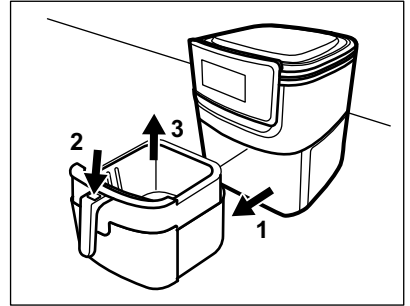

4. ضع الطعام في السلة حتى تصل إلى المستوى الأقصى. السعة القصوى للسلة هي 2 كجم.

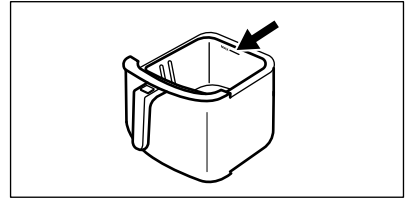

رمز	الإعداد
	140 درجة مئوية 15 دقيقة
	200 درجة مئوية 10 دقائق
	180 درجة مئوية 20 دقيقة
	180 درجة مئوية 45 دقيقة
	170 درجة مئوية 15 دقيقة
	180 درجة مئوية 15 دقيقة
	180 درجة مئوية 10 دقائق
	180 درجة مئوية 15 دقيقة

3. اضغط على: ①

- عندما ينتهي الطهي، تعمل مروحة التبريد لعدة ثوانٍ، ثم يتم إصدار إشارة صوتية. يمكنك تغيير الإعداد وإيقاف الجهاز أثناء الطهي:
- اضغط على رمز الطعام لتغيير البرنامج.
- ^، v - اضغط لضبط إعدادات مدة الطهي ودرجة الحرارة.
- ① - اضغط مع الاستمرار لمدة ثوانٍ قليلة لإيقاف الجهاز.

4.2 كيفية الطهي

ضع الطعام في السلة. وصل قابس الجهاز.

1. ① - اضغط واستمر في الضغط.
2. حدد الطبق من الطهي المساعد:

1. نظرة عامة

- 1 عرض
- 2 لوحة التحكم
- 3 السلة
- 4 قفل أمان مع غطاء حماية
- 5 مقلدة

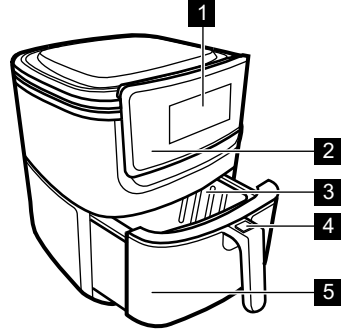

2. لوحة التحكم

2.1 لوحة التحكم

تعرف على الرموز الأساسية الموجودة على لوحة التحكم وعلى الشاشة.				
				
المدة	درجة الحرارة	أسفل	أعلى	التشغيل / إيقاف التشغيل
تقنية Assisted Cooking - الطهي مستخدماً الإعدادات التفانية لدرجة الحرارة ومدة الطهي.				
				
دجاج	أوراك الدجاج	شرائح اللحم	السمك	
				
المافين	بيتزا صغيرة	بطاطس مقلية	خضراوات	

2.2 عرض

- A. إعداد درجة الحرارة
- B. إعدادات مدة الطهي
- C. مدة الطهي / درجة الحرارة

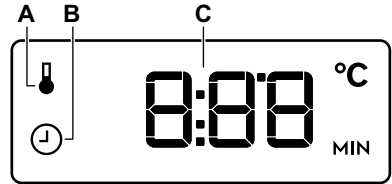

AEG



867361841-C-392020